

M2M-0017-120K

Silicon Carbide Power MOSFET

N-Channel Enhancement Mode

Features

- High Blocking Voltage with Low On-Resistance
- High Speed Switching with Low Capacitances
- Easy to Parallel and Simple to Drive
- Avalanche Ruggedness
- Halogen Free, RoHS Compliant

Benefits

- Higher System Efficiency
- Reduced Cooling Requirements
- Increased Power Density
- Increased System Switching Frequency

Applications

- Solar Inverters
- Switch Mode Power Supplies
- High Voltage DC/DC Converters
- Battery Chargers
- Motor Drives
- Pulsed Power applications

Package

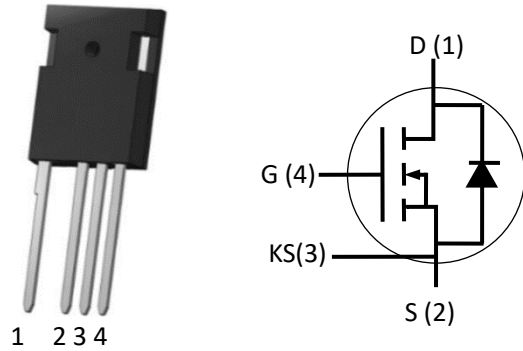

Part Number	Package
M2M-0017-120K	TO-247-4

Maximum Ratings ($T_c = 25^\circ\text{C}$ unless otherwise specified)

Symbol	Parameter	Value	Unit	Test Conditions	Note
V_{DSmax}	Drain - Source Voltage	1200	V	$V_{GS}=0V, I_D=100\mu A$	
V_{GSmax}	Gate - Source Voltage	-8/+25	V	Absolute maximum values	
V_{GSop}	Gate - Source Voltage	-5/+18	V	Recommended operational values	
I_D	Continuous Drain Current	97 85	A	$V_{GS}=18V, T_{VJ}=25^\circ\text{C}$ $V_{GS}=18V, T_{VJ}=100^\circ\text{C}$	
I_{DM}	Pulse Drain Current	200	A	Pulse width limited by T_{VJmax}	
P_D	Power Dissipation	600	W	$T_C=25^\circ\text{C}, T_{VJ}=150^\circ\text{C}$	
T_J, T_{stg}	Operating Junction and Storage Temperature	-55 to +175	$^\circ\text{C}$		

晁元國際半導體股份有限公司
MaxPower SiC Semiconductor Co., Ltd.

V1.0

Electrical Characteristics ($T_c = 25^\circ\text{C}$ unless otherwise specified)

Symbol	Parameter	Min.	Typ.	Max.	Unit	Test Conditions	Note
$V_{(BR)DSS}$	Drain-Source Breakdown Voltage	1200			V	$V_{GS}=0V, I_D=100\mu A$	
$V_{GS(th)}$	Gate Threshold Voltage	2.0	2.5	4.0	V	$V_{GS}=V_{DS}, I_{DS}=25mA, T_{VJ}=25^\circ\text{C}$	
			1.8			$V_{GS}=V_{DS}, I_{DS}=25mA, T_{VJ}=175^\circ\text{C}$	
I_{DSS}	Zero Gate Voltage Drain Current		8	100	μA	$V_{DS}=1200V, V_{GS}=0V$	
I_{GSS}	Gate-Source Leakage Current		20	150	nA	$V_{GS}=18V, V_{DS}=0V$	
$R_{DS(on)}$	Drain-Source on-state Resistance		17	23	m Ω	$V_{GS}=18V, I_D=75A, T_{VJ}=25^\circ\text{C}$	
			29			$V_{GS}=18V, I_D=75A, T_{VJ}=175^\circ\text{C}$	
g_{fs}	Transconductance		23		S	$V_{DS}=20V, I_D=75A, T_{VJ}=25^\circ\text{C}$	
			13		S	$V_{DS}=20V, I_D=75A, T_{VJ}=175^\circ\text{C}$	
C_{iss}	Input Capacitance		4150		pF	$V_{GS}=0V, V_{DS}=800V, f=100KHz$ $V_{AC}=25mV$	
C_{oss}	Output Capacitance		187				
C_{rss}	Reverse Transfer Capacitance		27				
E_{ON}	Turn-On Switching Energy		4622		μJ	$V_{DS}=800V, V_{GS}=-5/18V, I_D=75A,$ $R_{G(ext)}=10\Omega, L=99\mu H$	
E_{OFF}	Turn-Off Switching Energy		1354				
$t_{d(on)}$	Turn-On Delay Time		101		ns	$V_{DS}=800V, V_{GS}=-5/18V$ $I_D=75A, R_{G(ext)}=10\Omega,$	
t_r	Rise Time		55				
$t_{d(off)}$	Turn-Off Delay Time		129				
t_f	Fall Time		38				
$R_{G(int)}$	Internal Gate Resistance		1.0		Ω	$f=1MHz, V_{AC}=25mV$	
Q_{gs}	Gate to Source Charge		67		nC	$V_{DS}=800V, V_{GS}=-5/18V$ $I_D=75A$	
Q_{gd}	Gate to Drain Charge		148				
Q_g	Total Gate Charge		287				

Reverse Diode Characteristics ($T_c = 25^\circ\text{C}$ unless otherwise specified)

Symbol	Parameter	Typ.	Max.	Unit	Test Conditions	Note
V_{SD}	Diode Forward Voltage	4.7		V	$V_{GS}=-5V, I_{SD}=35A, T_{VJ}=25^\circ\text{C}$	
		3.6		V	$V_{GS}=-5V, I_{SD}=35A, T_{VJ}=175^\circ\text{C}$	
I_S	Continuous Diode Forward Current	97		A	$T_{VJ}=25^\circ\text{C}$	
t_{rr}	Reverse Recovery time	82		ns	$V_{GS}=-5V, I_{SD}=75A, V_R=800V,$ $di/dt=1400A/\mu s; T_{VJ}=175^\circ\text{C}$	
Q_{rr}	Reverse Recovery Charge	1156		nC		
I_{rrm}	Peak Reverse Recovery Current	26		A		

Thermal Characteristics

Symbol	Parameter	Typ.	Unit	Test Conditions	Note
$R_{\theta JC}$	Thermal Resistance from Junction to Case	0.25	$^{\circ}\text{C}/\text{W}$		
$R_{\theta JA}$	Thermal Resistance From Junction to Ambient	36			

Typical Performance

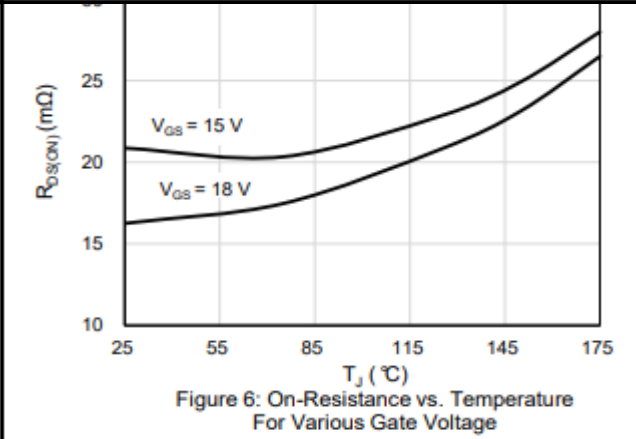
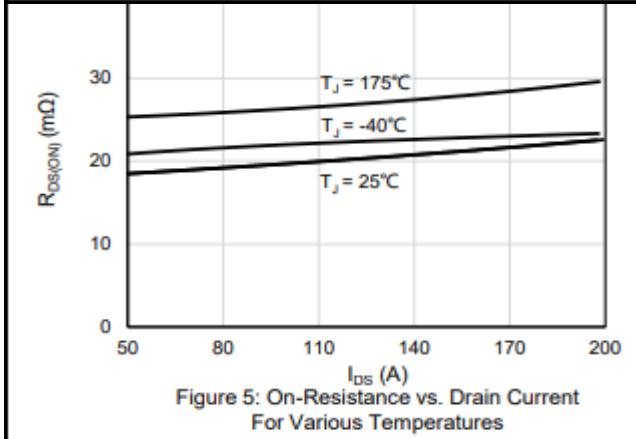
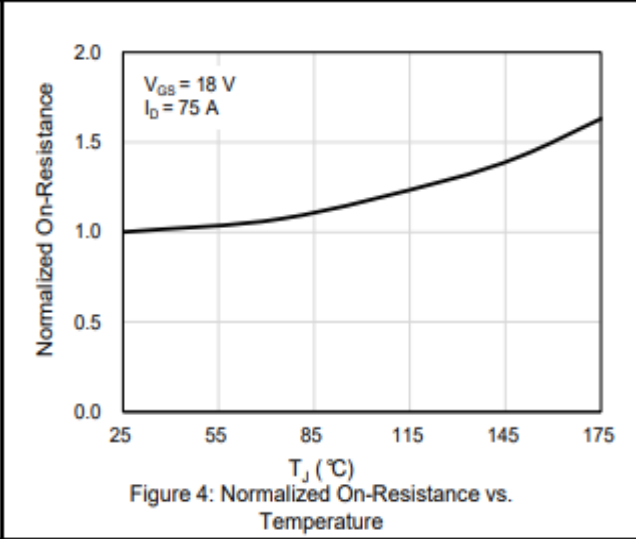
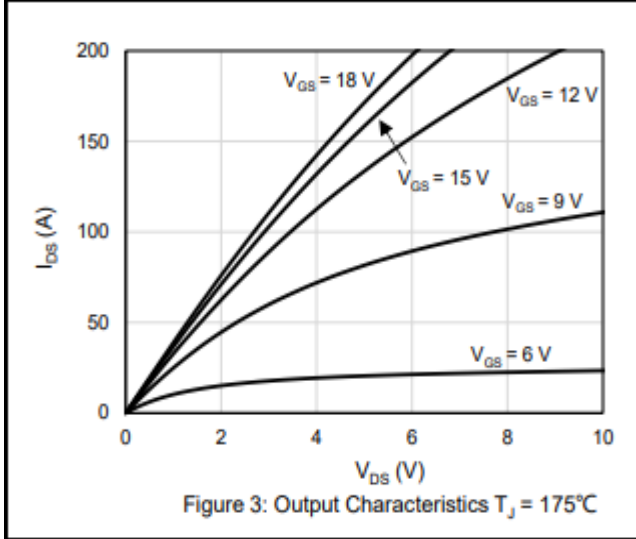
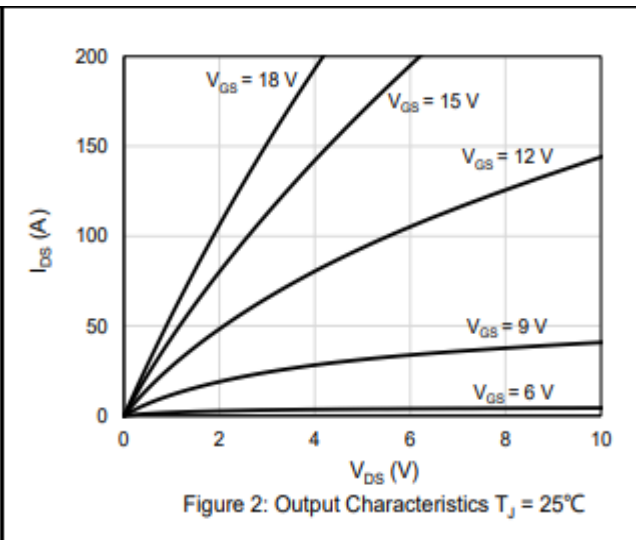
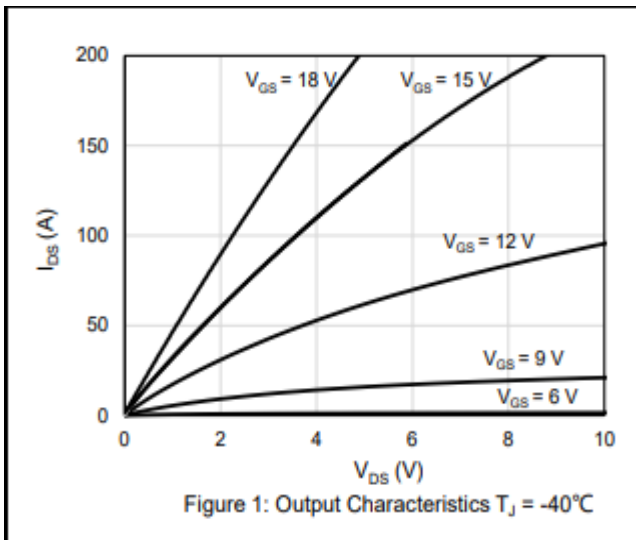

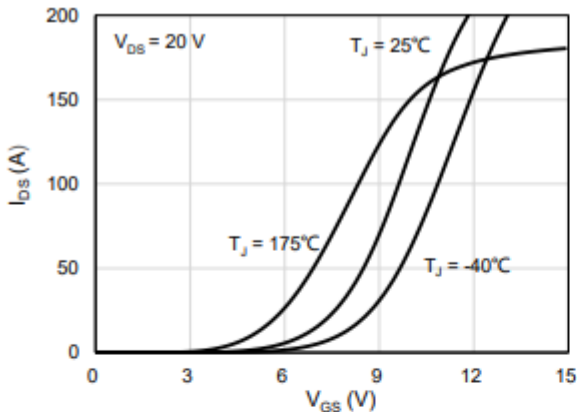

Figure 7: Transfer Characteristics For Various Junction Temperature

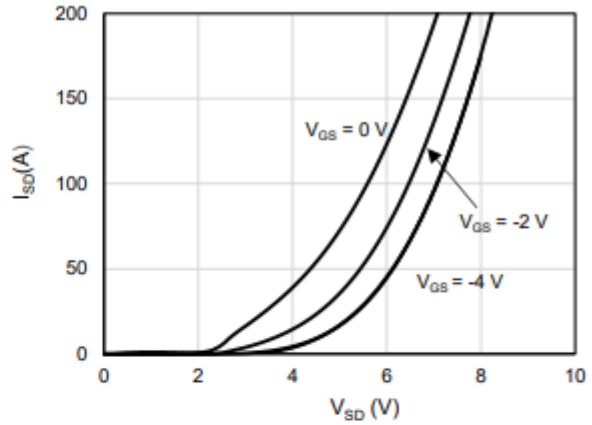

Figure 8: Body Diode Characteristics at -40°C

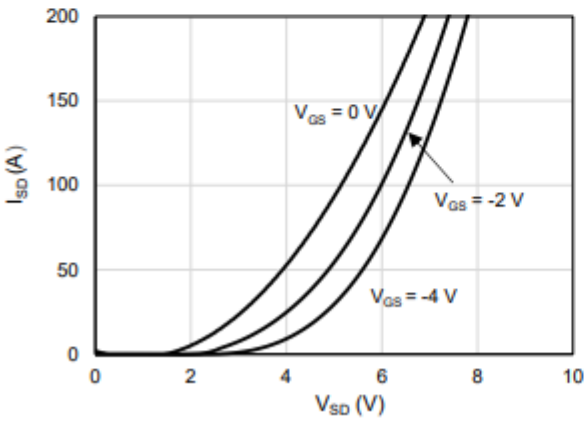

Figure 9: Body Diode Characteristics at 25°C

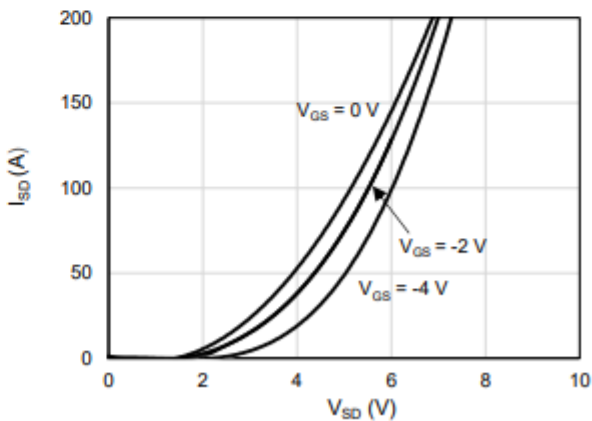

Figure 10: Body Diode Characteristics at 175°C

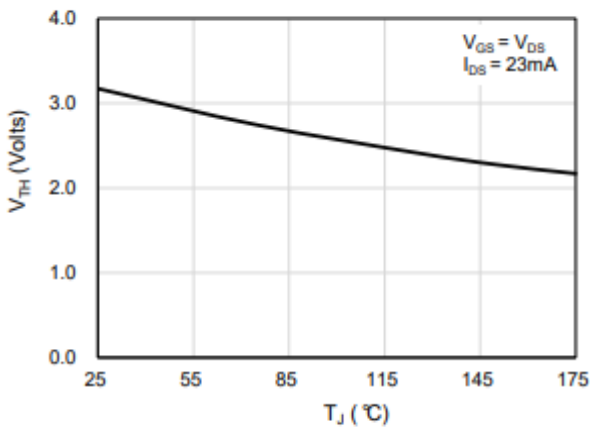

Figure 11: Threshold Voltage vs. Temperature

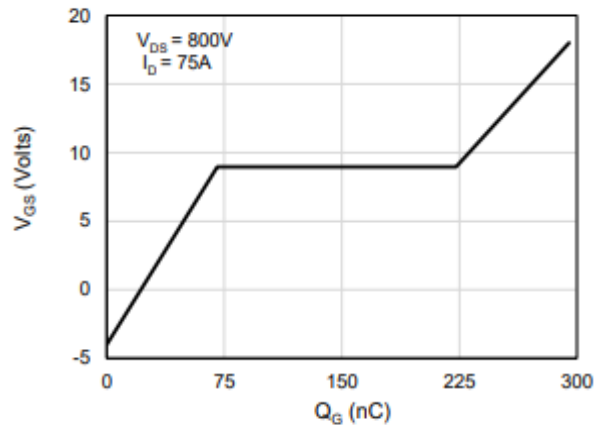
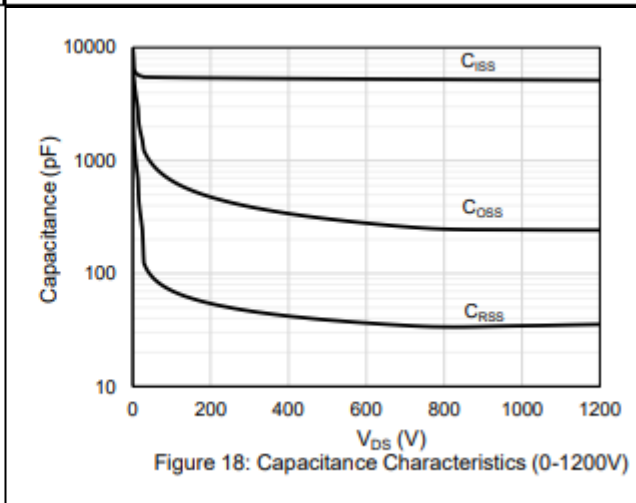
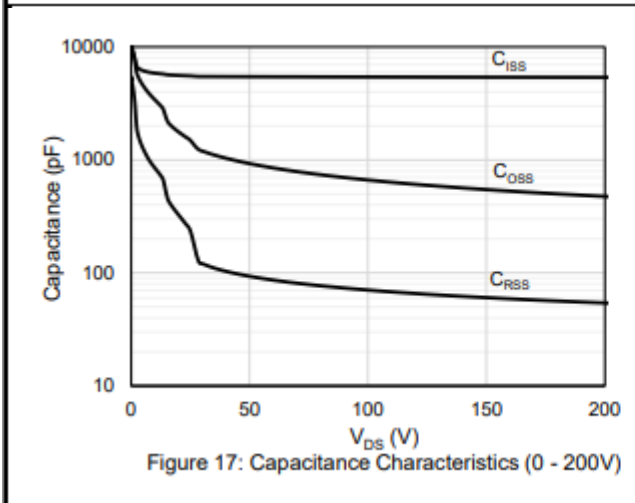
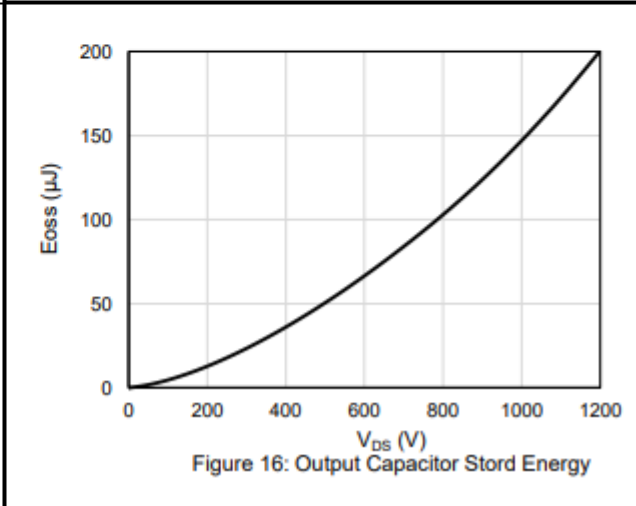
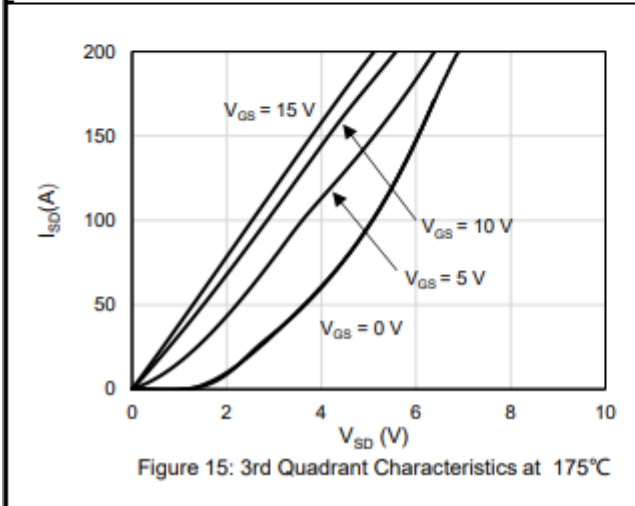
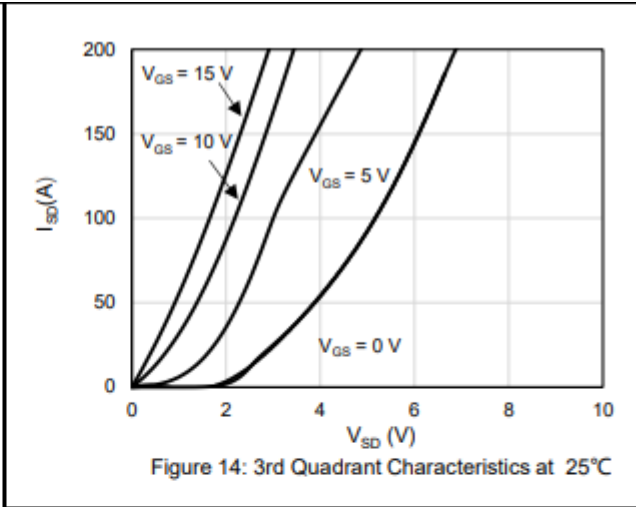
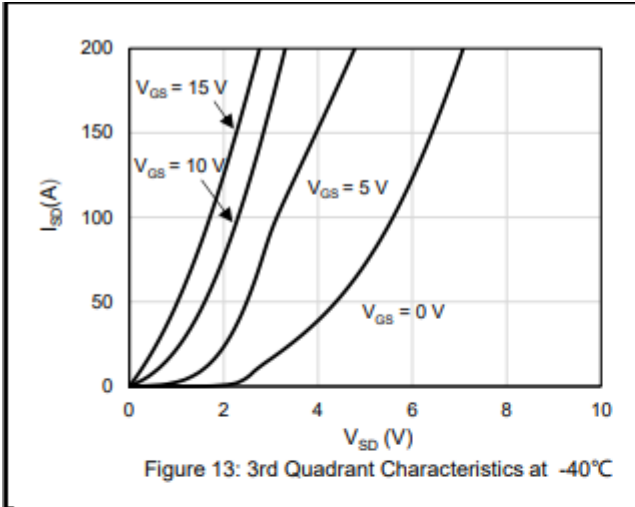
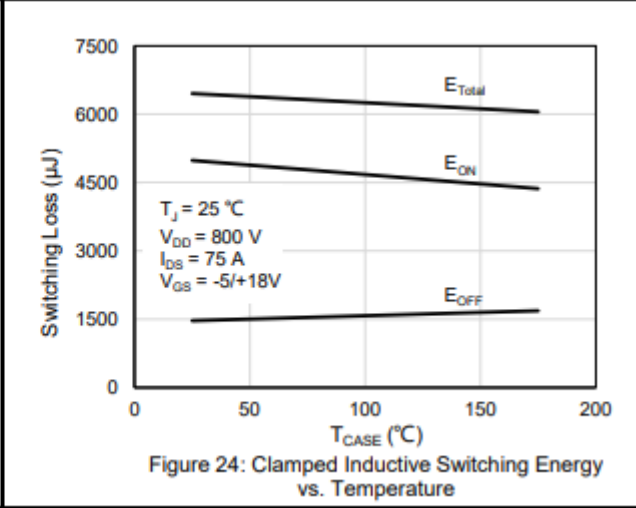
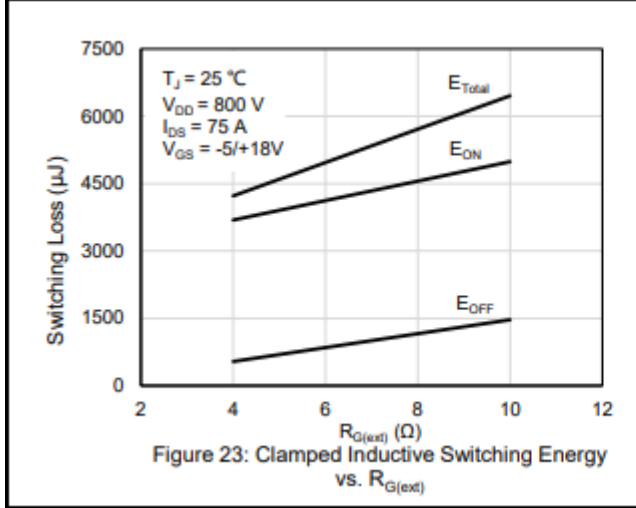
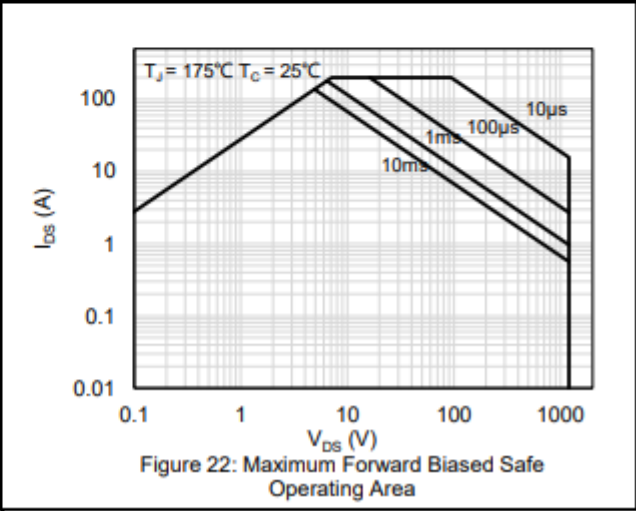
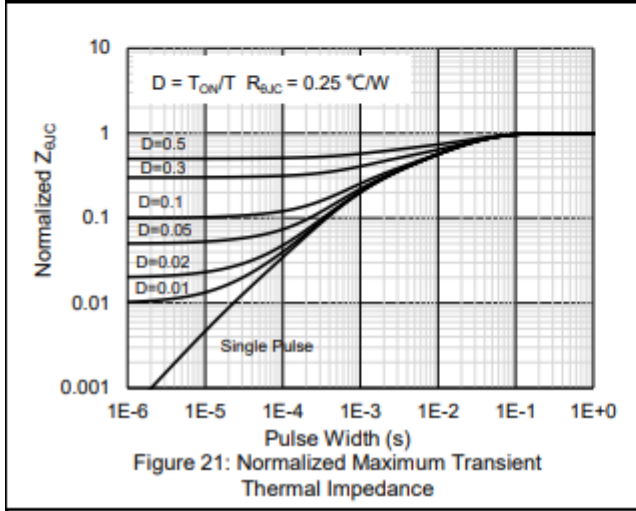
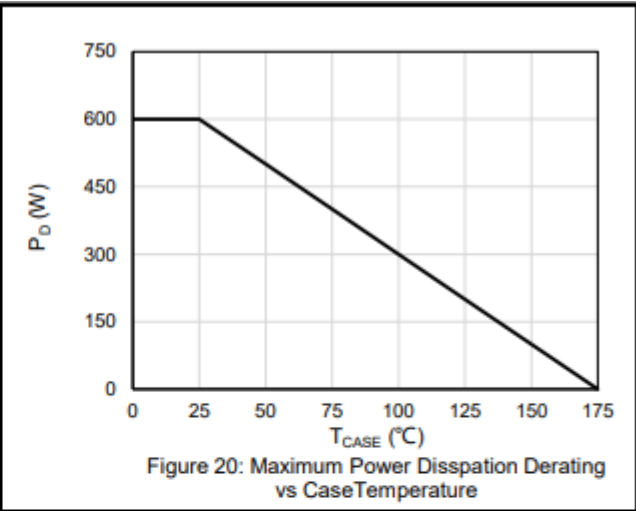
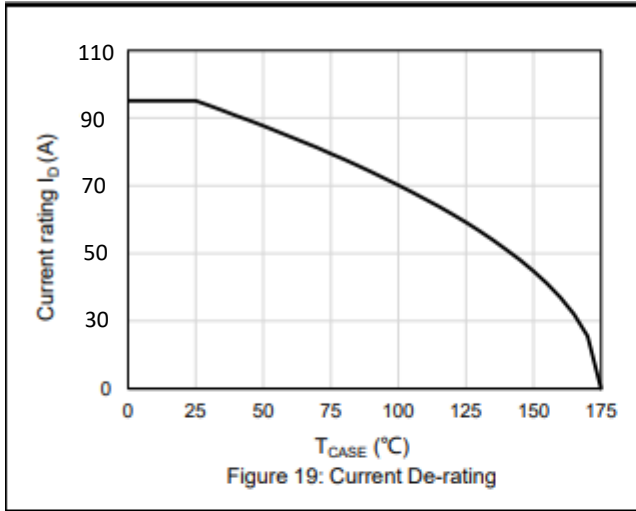

Figure 12: Gate-Charge Characteristics





Package Outlines

TO-247-4L PKG Outlines

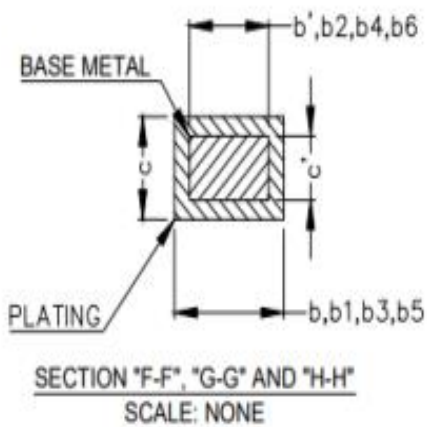
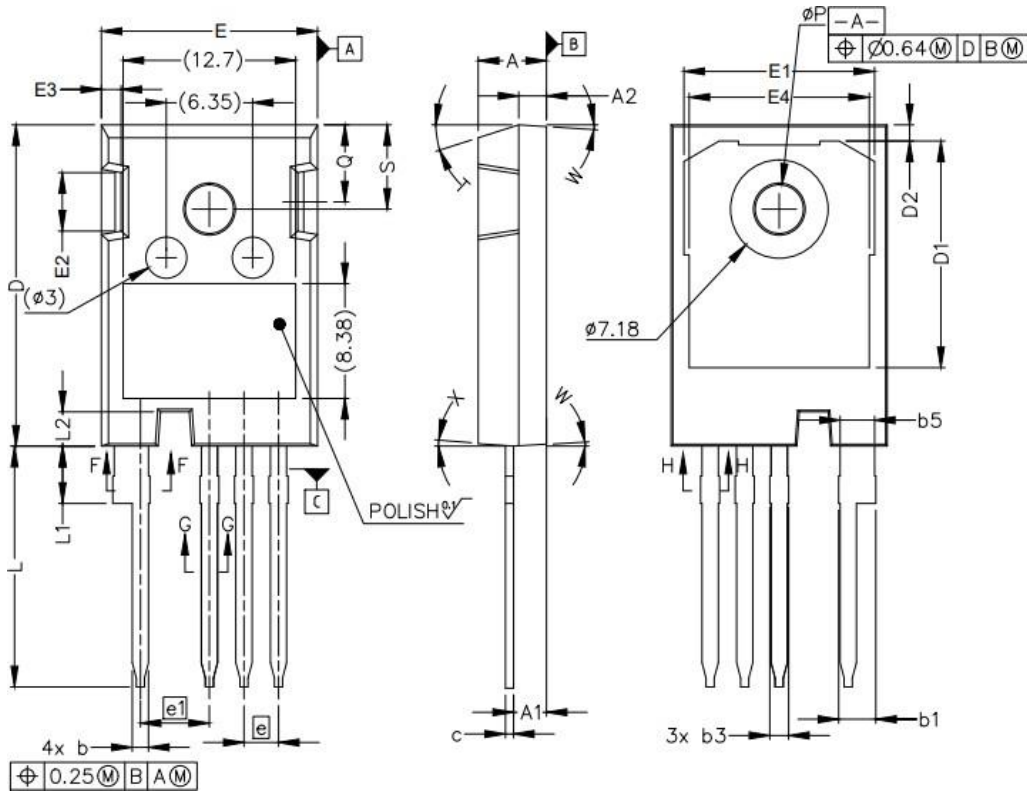

SYMBOL	MILLIMETERS	
	MIN	MAX
A	4.83	5.21
A1	2.29	2.54
A2	1.91	2.16
b'	1.07	1.28
b	1.07	1.33
b1	2.39	2.94
b2	2.39	2.84
b3	1.07	1.60
b4	1.07	1.50
b5	2.39	2.69
b6	2.39	2.64
c'	0.55	0.65
c	0.55	0.68
D	23.30	23.60
D1	16.25	17.65
D2	0.95	1.25
E	15.75	16.13
E1	13.10	14.15
E2	3.68	5.10
E3	1.00	1.90
E4	12.38	13.43
e	2.54 BSC	
e1	5.08 BSC	
N	4	
L	17.31	17.82
L1	3.97	4.37
L2	2.35	2.65
øP	3.51	3.65
Q	5.49	6.00
S	6.04	6.30
T	17.5° REF.	
W	3.5° REF.	
X	4° REF.	